



DUALTRON ULTRA
Electric Scooter
User Manual

DUALTRON ULTRA

The Legend of Electric Technology Powered by Minimotors in Korea

PERSONAL MOBILITY
User Manual



Brand Introduction

'DUALTRON' brand is a worldwide electric scooter brand name that Minimotors Co. LTD., is manufacturing.



Company Introduction

Minimotors Co. LTD., is a company who manufacture and distribute personal mobility with a professional production system since 1999.

Minimotors Co. LTD., has been making the electric mobility brand ←DUALTRON→ to meet the world people with the aim of making more innovative, more sensuous, and more convenient personal mobility from 1999 to the present and making a product that is loved by people in the world. Minimotors Co. LTD., Is doing its best to become the world best electric mobility company.



Before Reading Manual

01 This manual contains important information to help you use your product more safely. Failure to follow these instructions could be the cause of property damage and serious injury. For safe use, it is marked as 'Danger', 'Caution' and 'Warning' depending on the degree of danger and the meaning is as below.



Danger

Indicates a hazardous situation that could be a result of serious injury.



Caution

Indicates a potentially hazardous situation that could be a result in serious injury.



Warning

Indicates a potentially hazardous situation that could be a result in light injury.

02 Please read this manual carefully before using this product. If you have any problems with your product, you can get technical support from our head office or a seller. (www.dual-tron.com)

1. General safety guidelines	04
1) General safety guidelines.....	04
2) Safety guidelines before driving.....	05
3) Safety guidelines after driving.....	07
2. Safety precautions for Lithium battery	08
1) Proper lithium battery management tips.....	08
2) How to use a charger correctly.....	09
3. Product structure	10
4. Name of each part	11
5. Product components	12
6. How to use the product	13
1) How to assemble	13
2) How to unfold	14
3) How to fold	15
4) How to start	16
5) How to stop.....	17
6) How to charge	18
7) How to control emergency light and ride mode	19
8) How to control instrument panel	20
7. Maintenance	22
8. Core checklist	28
9. Product specifications	30
10. Memo	31

General safety guidelines

Caution

✓ For safety, please read the product manual carefully which is enclosed with the product.

1) General safety guidelines

(1) Be careful of water!



This product and components are not waterproof. Don't let the water get into the product and components. Never use it, if the road is wet due to the rain, snow, hailstone. If you wash or spread water to electric devices, it can result in malfunction or fire. Water damages will not be reimbursed; even during the warranty period.

(2) Beware of folding and spinning parts!



If parts of the body, as a finger or hair, get caught in the spinning or folding parts of the product, this may lead to severe injuries. Before driving, insure that no loose clothing or shoe lace will be caught in the wheels to prevent accidents.

(3) Don't tune by yourself. Electric shocks can occur!



Do not open or tune the electric parts (battery, controller or motor system). This can cause malfunction or fire. In such a case, damages will not be reimbursed; even during the warranty period.

(4) Abide by the local road traffic law



Unlicensed, driving after drinking, loading cargo on the scooter is prohibited. (More than bike or bicycle license is required)
Please comply with the Road Traffic Act and related laws and regulations according to the place of use.

(5) No acrobatics



Stunts and jumps such as jumping and dropping are prohibited as they can cause a great impact on the product and can cause of malfunction and accidents. Manufacturers and distributors are not responsible for any problems caused by this.

2) Safety guidelines before driving

(1) Be sure to wear safety equipment

1. For the safety of passengers, be sure to wear a full face helmet and the other protective gear (knee, elbow, hand, upper body).
2. Do not wear shoes such as slippers, high hills that interfere with driving.



Essential



(2) Required check before driving

1. Operate the throttle about 2-3 times before driving to check whether it can return to its original position, and operate smoothly while driving. Repeated bouncing or sudden operation may cause malfunction. If the throttle does not return to the original position while driving, if the brake is applied, the power of the motor will be automatically cut off, so it can be decelerated and stopped. Therefore, stop with using brake and visit the nearest repair shop for inspection.
2. Check brake operating status and replace pads and adjust adjusting the gap and brake clearance if the brake power is not enough.
3. If the tire pressure is lower than proper tire pressure(50psi), it causes a puncture or an accident. Be sure to check the tire pressure before driving.
4. Before driving, check the battery level after turning on the power.
5. Nighttime driving should be avoided for safety reasons. If you have to ride at night, ride at a slow speed with checking the light position and the light condition.
6. Set the mode that suits you.
7. Practice slowing down and stopping to cope with unexpected situations that may occur while driving.
8. Decelerate enough to avoid overturning when turning left or right. Make sure that there is no obstruction, then turn slowly, keeping a wide radius.
9. If you need to go backward, it would be safe if you move after stopping and getting off.

(3) Check the main fastening condition



1. Check the tightening condition of all the bolts and nuts constituting the product and check if there is any missing. Need to check the tighten condition of folding lock(Parts related to the folding as a QR lever, a QR slider, a hinge center bolt, a headset nut, a swing arm) and check if there is any clearance.



2. Check if the folding lock and the QR slider are placed in the proper position. And use after checking the QR lever is locked completely and folding part is locked firmly. If there is any problem, need to check by yourself or visit the nearest repair shop before using.



General safety guidelines and restrictions

(4) Advice for beginners, pregnant women, and elderly people

Beginners and elderly people should only use slow mode as there is a high risk of causing accidents, when using high speed. Pregnant women should not ride a scooter.



(5) Do not accelerate downhill

If you accelerate downhill, the braking distance is too long to be dangerous. If necessary, use the brakes properly. On very long downhill roads, the brakes may overheat and may not work.



(6) When lifting the product after folding the handle

When folding the handle and lifting the product by lifting the handle, the load of the main body may be concentrated on the folding part, which may damage the folding part. When folding the handle and lifting the product, Hold the body(Deck) with both hands as shown in the picture.



(7) Be careful when reassembles the bolt after removing the side cover



If you reassemble after removing the deck for inspection of the controller or the battery, make sure that the bolts are standard and if the rubber seal is on . If you assemble without a spring washer or use a bolt longer than the standard, the bolt will penetrate the battery, which cause a serious damage to the battery and serious safety problems such as fire.



(8) Getting on

This product is for one person and it is prohibited to ride with an infant or ride with the two passengers. It can be cause of product breakdown and accidents. (Refer to the specification table for the recommended boarding weight).



(9) Handlebar



The handlebar is designed for turning a direction and setting a balance. Both handle should hold the handle while driving and it causes the accident if hold with only one hand. Pulling or pushing with excessive power or attach too many attachments on the handle would cause malfunction or accident.

(10) Side kickstand



If you board or ride on the scooter with the side kickstand on, it causes the product to be damaged and safety accident. Do not apply excessive force to the side kickstand.

(11) Safety guidelines during driving

1. Do not use in places where slippery is likely to occur, roads, traffic congestion, rough roads, pavement or roads where there is a risk of accidents, roads where the road surface is uneven.
2. For the safety of pedestrians, when crossing the crosswalk, get off and drag the product. And driving on the sidewalk is prohibited.
3. Do not ride while threatening animals, pedestrians and any other means of transportation such as bicycles, motorcycles, cars, etc.
4. In case of crossing the speed bumps and obstacles, be sure to slow down to less than 5km/h. If it crosses with high speed, it may cause product malfunction and accidents.
5. When decelerating or braking, it is necessary to stop by using the brake appropriately. Braking by foot or sudden braking by front brake may cause a safety accident.

Information

*In such a case, stop driving immediately : If you encounter any of the following situations while driving, stop driving immediately and contact your nearest repair shop for appropriate measures. If you provide pictures and videos for accurate diagnosis, it is easy to get professional counseling.

- Unusual heating of the motor
- Abnormal noise is generated
- Brake braking status error
- Smoke, ignition from scooter
- Error message on the instrument panel
- Other reason when it is judged that driving would be difficult
- Throttle doesn't return to its original position

3) Safety guidelines after driving

Motor and brake burns caution



Since the temperature of the motor and brake (especially the disc rotor) increases after running, there is a risk of burns.



Safety precautions for Lithium battery



1) Proper lithium battery management tips



1. Be careful not to expose the lithium battery for children or pets.
2. (a) Lithium battery is affected much by external temperature. In the winter when the temperature is low, the performance of the battery may be temporarily decreased, and the mileage and output power is decreased, but it returns to its normal temperature when the weather becomes warm.
(b) If the battery requires replacement after long-term use, replace it with a new one through an authorized dealer. The discharge capacity of the lithium battery normally decreases more than 15% after 300 times of cycle use.
3. (a) Only use the charger that was supplied with your product to charge the lithium battery. Using an unauthorized charger could cause fire or serious damage to the battery. Only use the charger that was supplied with your product to charge the lithium battery. Using an unauthorized charger could cause fire or serious damage to the battery.
(b) When charging with a charger which is not genuine, it could cause a fire.
(c) Charge the lithium battery in a dry, open, and well-ventilated place. Do not charge the battery near inflammable goods.
(d) Charge lithium battery within 0-45°C and discharge within -20-60°C. Charging and discharging the battery not within the appropriate temperature may damage the lithium battery and may occur malfunction, fire, explosion.
(e) If you bring your product from outside to inside in winter, the change of temperature may cause dew condensation. In this case, do not charge immediately, but wait for the battery to cool down about 1-2 hours. Otherwise, the battery's lifetime and capacity might get reduced.
4. (a) Do not leave lithium battery in any place exposed to direct sunlight or high temperature. Always store it in dry places in room temperature (10-20°).
(b) When the scooter needs to be stored long time without using, keep it by charging around 70-80% from the max charging. (Never keep full charge)
5. (a) If the battery protection circuit is damaged, the battery emits an unusual smell, or the battery leaks, contact a repair shop immediately and get technical support.
(b) If overheat, smoke or ignition is detected in the product with lithium battery, immediately stop charging or use, and move the product to outdoor as soon as possible, and then use a fire extinguisher to evolve. Do not spray water or immerse the product in order to evolve, as this is more dangerous.
(c) The lithium battery pack is very high in energy density, so it may be ignited if it is charged for a long time under short-circuited, leaked, or short-battery condition. Therefore, you should avoid charging for a long time in the absence of a person, and charging must be done while the person is aware that the risk of unexpected fire can be avoided.
6. If the terminal for charging/discharging of lithium battery has a changing the polarity, or shocking, the battery may cause malfunction or fire. If you think that the battery has been shocked, you should stop charging and using it and visit the nearest point to inspect it.

7. Keep the lithium battery in a safe place out of the reach of children and pets.
8. Do not disassemble or incinerate the lithium battery. Dispose the battery as industrial waste and be careful that no short-circuit occurs in the terminals
9. When disposing of a lithium battery, the battery should be separated from the product at the point of purchase or near the point of purchase so that the charging terminal is not short-circuited. Dispose of it as industrial waste when disposing of it.
10. When disposing the lithium battery, the battery must be separated to avoid the charging terminal is short-circuited. Dispose it as an industrial waste when disposing it.

2) How to use a charger correctly

1. Before using the charger, please carefully read and understand the following usage instructions and use it safely.
2. If the lamp of the charger does not light, charger fall, strong external shock, long time charge, or wire covering damage, stop using immediately and contact the service center for proper measures.
3. Always use only genuine chargers. Use of a charger other than the charger will not guarantee performance and safety, and may cause the charger to fail.
4. The charger is not waterproof. Water inflow into the charger may cause malfunction, electric shock or fire, so be careful not to infiltrate with water.
5. This charger is forbidden to be used in places where there is high humidity, open flames, flammable materials, confined spaces, indoors or in a car.
6. Any disassembly, modification, or use with other chargers may cause malfunction or fire, and the manufacturer and distributor are not responsible for any problems caused by them.
7. Charger failure may cause a fire during charging, so be sure to unplug the charger when you are away from home for a long period of time.
8. Children and pets should not be allowed to come into contact with the charger as they may cause an electric shock.
9. If metal is inserted into the charging hole, a short circuit may cause electric shock or fire.
10. After unplugging the charger, do not touch the plug for about 10 seconds. This is to prevent electric shock due to a brief discharge.
11. If the terminal is disconnected during charging, the internal circuit of the charger may be stressed to cause a malfunction.
12. Do not operate the product during charging. It may cause the charger to malfunction.
13. When charging, the charging terminal should be firmly contacted. Do not use if the terminal is corroded.
14. When disconnecting the charger from the product, it is safe to pull out the cable without pulling out the cable.

Electric wiring diagram

DUALTRON ULTRA WIRING DIAGRAM

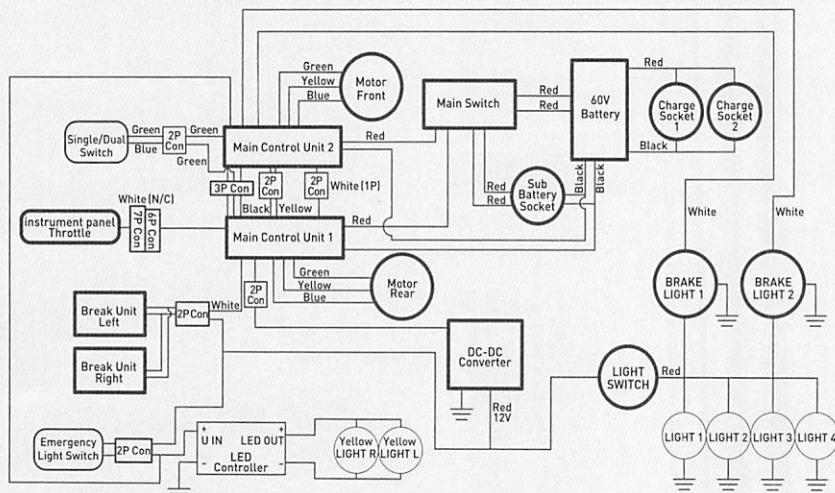

Product size (Length x Width x Height)

Unfolded size(123 x 60 x122cm). Folded size(123 x 60 x 52cm)

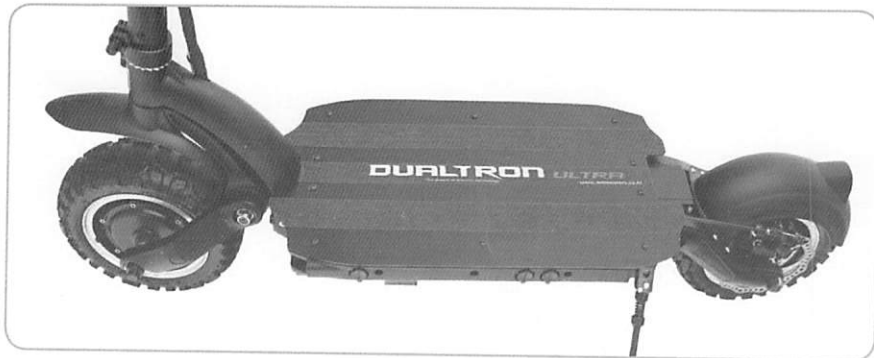

Name of each part

DUALTRON ULTRA



Important notice

- * When turning on the product power Turn on the (25) Main power switch in advance (Internal battery driving basis) and turn on the 1) LCD instrument panel for starting driving. Turn off the power to reverse order after driving.
- * Dualtron Ultra instrument panel power may turn off automatically if it is not used for a few minutes. As the light also turns off, turn on the instrument panel and push the light button to turn the light on.

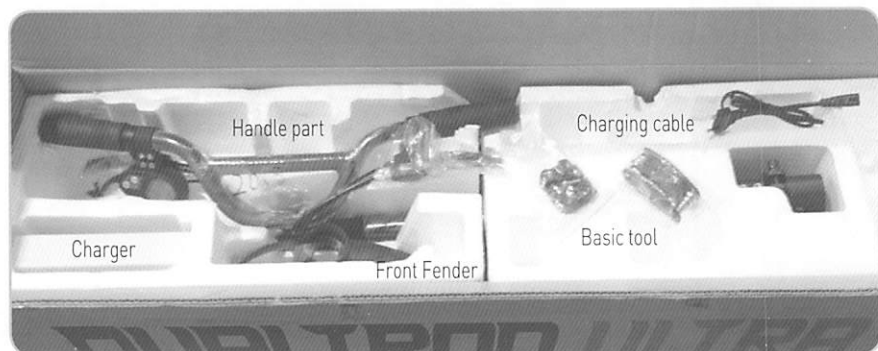

Check the components inside of the box

Top: Handle part / Default charger(2A), Default tool, Front fender, Charging cable

Bottom: Body(Lithium battery included), User manual

As shown in the picture above, the box consists of two stages and contains the contents related to the product. Please check if the contents are the same as the picture when you open and please get the help of the service center if the user can not assemble it.

* Battery pack of each model is installed with the product when it is shipped.

After assembly



How to check the product serial

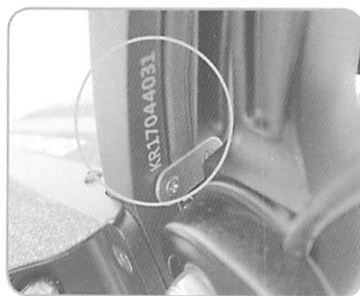

After open the box of product, note serial numbers and keep it for easy recognize.

1) How to assemble

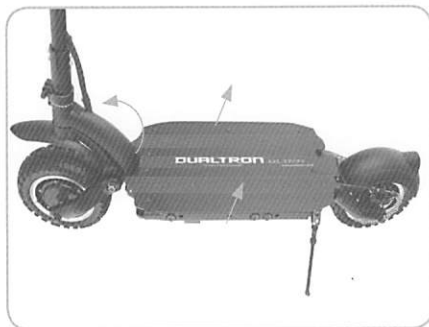

(1) Product remove

1. If the product is lifted with only handle bar, the inner shaft may be damaged due to the much load on the folding parts.
2. Therefore, when lifting the product, it is better to raise the handle bar first, then lift the body(deck part) of the product with both hands and lift it slowly to prevent damage to the folding part.



(2) Assembling handle bar

1. Loosen the screw on the handle mount with a 5mm hex wrench included in the basic tool. After aligning the handlebar with the center, cover the cover of the mount and tighten the fixing bolt.
2. Do not tighten all the bolts at once and tighten it in the order of 1-4 tightly.



(3) Assembling front fender

1. Loosen the fixing bolt of the front fender.
2. Put the front fender to swing arm.
3. Put the fixing bolt into the bolt hole again and turn it to clockwise.
4. When it gets into well, use a 4mm hex wrench in the basic tool to tighten.
5. Tighten fully until it doesn't turn any more.

How to use the product

2) How to unfold

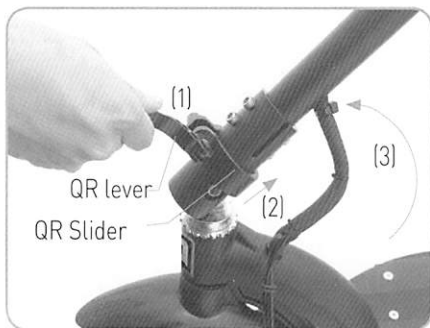

(1) Releasing QR lever

After unfolding the QR lever outward, pull up the clamp set and raise the handle post.

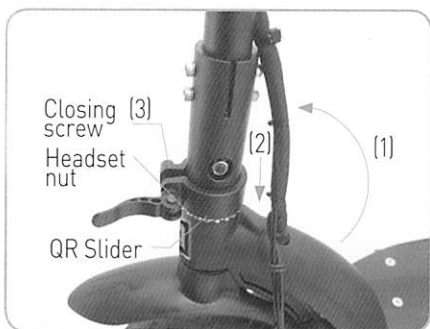

(2) Raising handle post

When unfolding the handle post, raise the handlebar while pushing the deck with foot, and then lower the QR clamp set down completely and tighten the finishing screws on the right.



(3) Fixing the folding part

When the QR lever is locked inward as shown in the picture, the handle unfolding is completed. If the folding lever is not completely locked, a safety accident while driving can be occurred. Before and after running, always check if there is a gap in the folding part, and a folding part or handle part, the bolt&nuts of all the fixing parts of the product are properly tightened and the fastened parts are not loosened.

3) How to fold

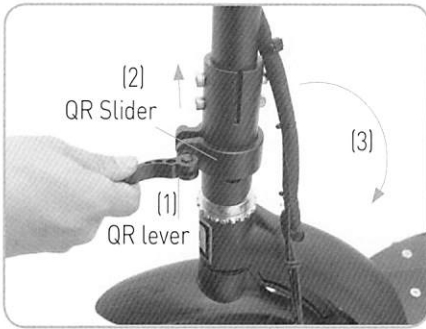

(1) Releasing fixing folding part

Unfold the QR lever outwards and pull the clamp set up, and then lay the handle post in the direction of the arrow.

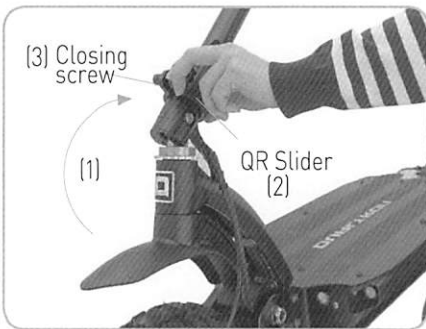

(2) Folding handle post

When folding the handle post, hold the post and lower it toward the deck. Raise the QR clamp set up and tighten the right finishing screws.



(3) Fixing folding part

Fold the QR lever inward as shown in the picture and fix it to complete the product folding.

How to use the product

4) How to start



(1) Turning on the main switch

When the button of the main power switch is set to 'I'(IN), the built-in battery and the BMS are activated and ready to start driving. When driving is finished, press 'O'(out) of the main switch to prevent battery consumption.



(2) Turning on the instrument panel

After turning on the main power switch, press the power button on the instrument panel for 2 seconds to turn on the instrument panel. Users can determine the appropriate departure speed for users, using the cruise mode and using the electric brake, etc. in the detailed mode.

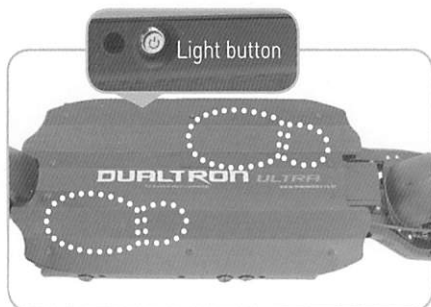

(3) Stance for driving

After tilting the kick stand, find a stable position on the deck and then hold the handle grip comfortably. (Be sure to turn on the light button when driving at night.) Be careful not to raise your foot on the rear fender.



(4) Change of acceleration, deceleration and driving method

Acceleration can be performed by using the throttle of the instrument panel while driving, and the deceleration or stop can be performed by holding the brakes on both handles. Yellow is the emergency light button and the emergency light flicks when the button is pushed or use brake. And red is the motor system selection button to select the appropriate driving for user.

5) How to stop

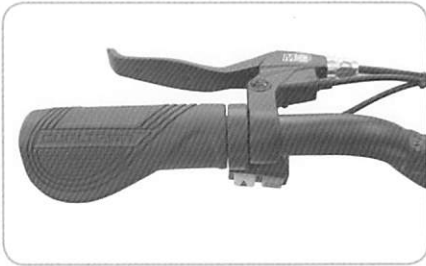

(1) Decelerate with rear brake

When stopping while driving, use the rear brake to decelerate slowly. There is a risk of overturning when braking suddenly with front brake. It is necessary to practice to stop after decelerating safely with the rear brake.

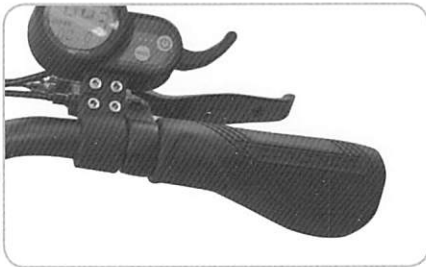

(2) Stop safely

Always use the front and rear brake levers together to stop smoothly and safely after decelerating with the rear brake.



(3) Deceleration and brake with electric brake

Be sure to set whether or not to use and strength of the electric brake among the detail functions of the instrument panel beforehand. If the use of the electric brake is set, the electric brake works together with the brake lever when driving to increase the braking power.

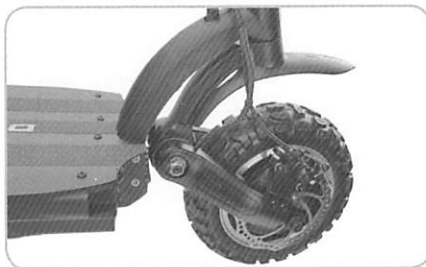

(4) Check for safe braking

For safe braking, be sure to check for any external changes (bending, exfoliation, disconnection, etc.) on the brake cables and lines before driving. If the braking force of the brake drops considerably even during use, it should be used after the inspection and repair.

How to use the product

6) How to charge

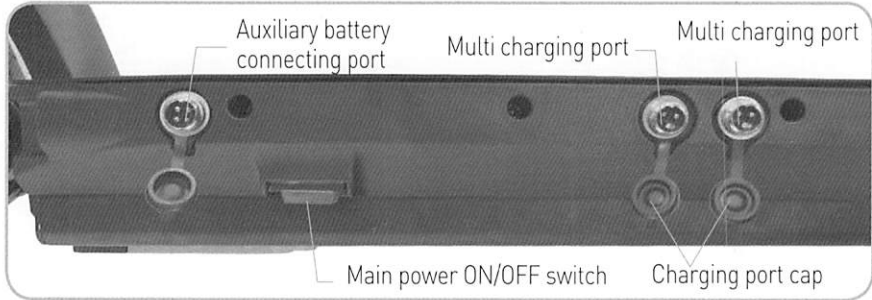

(1) Standard charging method

1. As shown in the picture, you can open one of the two right-side charging ports and connect them to the charger connector and connect them into a household outlet.
2. Charging status indicator, Red: not fully charged, Green: fully charged.
3. Be sure to close the charging port cap when driving and storing except when charging.
4. When connecting the connector to the charging port, metallic sparks due to the voltage difference may occur, but this is normal.



*** CAUTION: Do not multi charge the battery in case of quick charging. If you want to charge with the two chargers, you must use the 2A charger.**

(2) Charging method when using multi charging socket(Option)

1. Make sure to use only the genuine 2A charger(It may cause electrical trouble when using non-standard charger and cause serious damage to the battery.)
2. All chargers connected to the socket should use the same charger only. (Do not mix different chargers with each other.)
3. Connect the charger connector to the main body first, then connect the charger to the charger connector before connecting the AC cord.
4. If the charger indicates green light, it is fully charged, so disconnect the AC cord of the charger and remove the socket from the main body.



***CAUTION: The high capacity (rapid) charger must be a genuine from Minimotors. Do not charge more than two of the genuine high capacity charger at the same time. The use of a non-genuine high capacity charger and a charger of different voltage can cause fatal damage and fire of the electrical system.**

*** Frequent use of the rapid charger can shorten the battery life in a short time. Do not charge in situations where you suspect that water has been entered, such as flooding, rain, or splashing water.**

7) How to control emergency light and ride mode

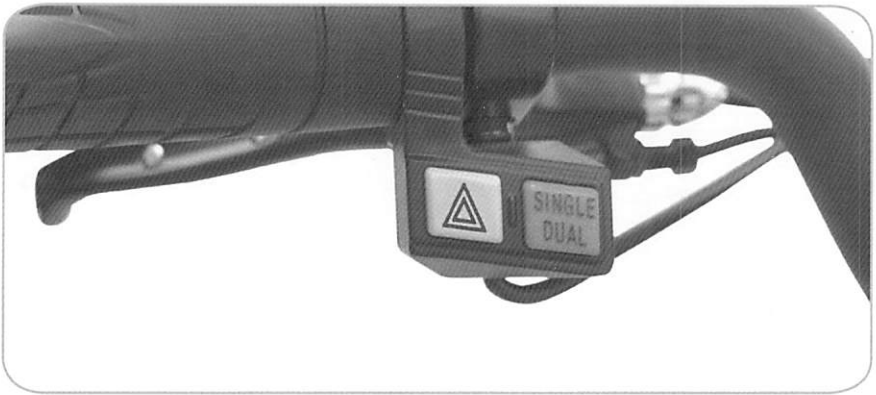

(1) Using the flashing emergency light button (yellow)

When you press the left yellow emergency light selection button, two tail light blinks when the brake is operated. Use it as shown.

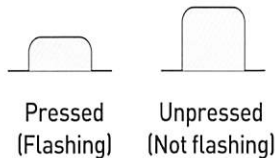

(2) Using the motor system selection button (red)

The red motor system selection button is a selection button that determines whether to use only one motor or two motors. If you want efficient energy driving, single drive is recommended. Operate in case of dual or single switching during operation without operating the accelerator.

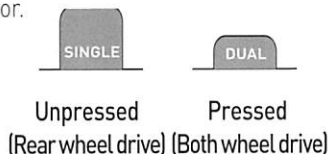

How to use the product

8) How to control instrument panel



(1) Instrument panel main screen → Adjusting the speed step

To adjust the speed level in the main screen while the instrument panel is on, press \odot to display the currently set speed level. At this time, press \rightarrow the button to set the speed step (L1 - low speed, L2 - medium speed, L3 - high speed). Press \odot to confirm the set speed step value and finish setting.

Information

* When L1 (low speed) is selected, slow start does not work even if P7 (start mode) is set to slow start in the detail function.

(2) Mode functions and setting method of main screen

Each time you press \rightarrow the button briefly on the main screen, the mode changes to the next mode.

Mode	Description
TRIP	Current mileage (Press and hold the mode button to set "0")
ODO	Accumulate mileage
CHA	Not used
VOL	Current voltage(Volt)
DST	Not used
TIME1	Power ON time

* Note: The voltage displayed in VOL mode has about 1V ~ 2V difference from actual battery voltage

(3) Returning to the main screen after setting details

Press \odot again to finish all settings and return to the main screen

(4) Setting detail functions of the instrument panel

Mode	Display values and settings
P0	10(Can not change)
P1	48(Can not change)
P2	15(Can not change)
P3	0(Fixed)
P4	Speed display / Km/h(0), mp/h(1)
P5	Start mode / Accelerator start(0), Kick start(1)
P6	Cruise mode(Auto driving) / Off(0), On(1)
P7	Start speed / Slow start (0), Power start(1)
P8	Max speed setting / 1~100%
P9	Electric brake power / Off(0), Medium(1), Hard(2)

* Press \rightarrow to move between P0 mode and P9 mode, and press \odot to change the setting value.

(5) How to enter or return to the detail function setting screen from the main screen.



Ex) P0 default value setting

You can return to the normal screen or entering the function setting of the instrument panel by pressing the power button together with the mode button to the right index finger and the left index finger on the main screen.

Press MODE and POWER button for about 2-3 seconds to enter P0 mode. → Press once to change set value. → The setting value is blinking and displayed below. At this time, press the button to change the setting value. → Press the button to increase the setting value, and press to decrease the setting value.

* When the setting is finished, press the for 2-3 seconds to activate the setting value.

(6) Features of cruise mode

The cruise control function allows you to maintain the driving speed automatically. The advantage of using the cruise function is that you can reduce fatigue during long distance driving and fuel consumption.

1. Starting the Cruise function

- Select the Cruise function part of the instrument panel as 'Settings'
- If the throttle is kept at the same acceleration for about 7 seconds, the cruise function starts.

2. Ending the cruise function

When you hold and release the brake while the cruise mode is running, the cruise mode is automatically canceled.

3. Precautions when using the cruise function

In order to release the cruise function in response to the safety situation while driving the cruise function, be sure to travel in a position where the brake can be used immediately so that the brake can be applied. When switching single mode to dual drive mode in a cruise mode, cruise mode can not be released with using throttle and can only be released via the brakes.

(7) Intensity adjustment of electric brake

The Dualtron Ultra is equipped with a physical brake that brakes the front and rear wheels and can be braked by pulling the physical brake lever on the handle. If '1' is selected for P9 of detail function setting of the instrument panel, it is medium intensity and if '2' is selected, it is a hard intensity which the maximum braking force. If '0' is selected, the electric brake operation will be off

1. The electric brakes will not be operated when the battery is fully charged.

Since the electric brake may not operate when the battery is fully charged, be aware of this and operate the unit with the electric brake. If the battery is running low, the electric brake will operate normally.



2. Precautions when using the electric brake

Be careful of safety hazards as it may cause slip If both front and rear electric brakes operate simultaneously when the electric brake is operated.

Maintenance

1) Self-diagnosis through instrument panel

Fault type	Diagnosis	Solution
(2)	System error	* If the fault information display appears, please contact the service center quickly. Stop using the product immediately. You can avoid damage to people and products.
(3)	Motor error	
(4)	Accelerator error	
(5)	Controller error	
(6)(7)(8)(9)	Not applicable	



* The number (1) is displayed when the cruise function is run at a constant speed.

2) How to check the product daily before and after driving

(1) Check brake and cable

- Before driving, make sure that the braking force is sufficient and the operation is good.
- If the braking force of the brake drops considerably even during use, it should be used immediately after the inspection and action.
- When checking, make sure that the brake pad is not worn, the cable is not loose, and the cable is not damaged.
- Brake cable is a consumable item depending on the user's driving environment. When operating the brake lever, if there is a feeling of being caught unusually or when operating noise is occurring, check if the inner wire of the cable is partially broken, worn or deformed. If you do not pay attention to repetitive handle folding, the brake cable may be broken or deformed, which may cause the operation to be ineffective or the wire may be broken unexpectedly due to damage of the inner wire. Be sure to check before you drive to decide whether to replace or drive.
- Make sure that the bolts, nuts and the various fixing parts of the brake are not loose, and the disc is not deformed or damaged.

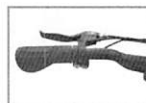

(2) Tire pressure check and uneven wear caution

- Check the condition of the front and rear tires. Check the condition of wear and puncture and keep tire pressure (proper air pressure 50) properly. When the air pressure is insufficient, the travel distance becomes shorter and the possibility of puncture increases.



- It may cause uneven wear of tires when the tire is suddenly stopped and which makes dangerous situation. Therefore, it is necessary to judge the replacement time by observing the appearance of the tire.



(3) Check tightening of the parts such as folding part and handle part

- Check the product thoroughly before use.
- Always check if there are gap in each part, the bolts and nuts of the folding and handle parts, and if the whole fixing parts of the product are properly tightened and if the fastened parts are not loosened.

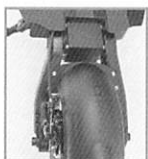

(4) Checking when to replace consumable parts

- The rubber inside the Dualtron Ultra rubber suspension is a consumable part that may be cured and the elasticity would be reduced as the product is used and it may result in a slight reduction in the performance of the suspension. If the suspension is not functioning well, you should visit your nearest service center and replace the rubber.
- Spare parts such as tires, tubes, discs, pads, cables and brackets, forks, etc., which require periodic inspection and replacement are subject to replacement at different times. Therefore, periodic inspection and maintenance is required.s

(5) Electric products can be damaged by various factors!



- As with all machines, this product may also fail due to a number of factors. The life of each part can be different depending on the driving habits. Parts exceeding the durability of the product may be damaged and cause accidents. Brake cables and various cables as well as forks or brackets on the machine are consumables that can become worn or bent depending on the external driving environment. Therefore, it is recommended to visit the repair shop for replacing and safety inspection as the basic shape deformation, cracking due to compression, crack or discoloration which shows the durability of the product is low

Maintenance

3) Brake adjustment method

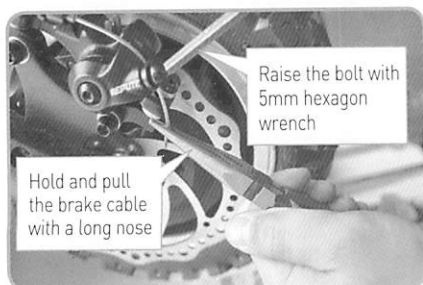
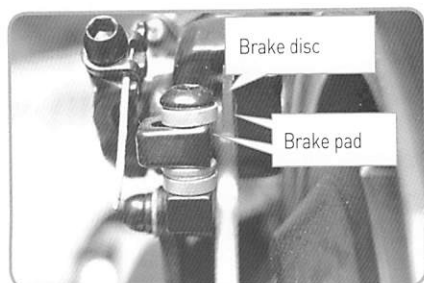

As you continue to use the brakes, the brake pads become worn out and the gap between the pads and the brake disc becomes wider. When the braking power drops, it can be adjusted simply as shown in the picture below.

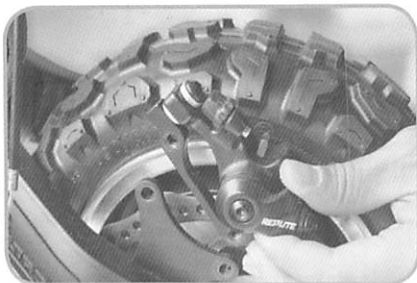

(1) As shown in the picture, if you release it with a 5mm hexagon wrench, the caliper will be detached.

(2) Caliper will be separated as the picture

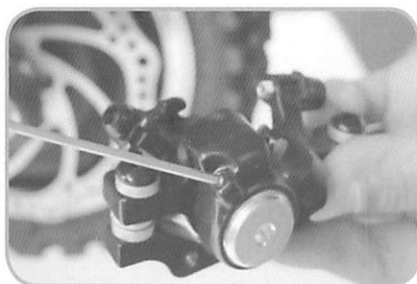

(3) A small set screw hole is shown in the picture. The role of this bolt is to keep the brake pads on the motor stationary. So, after adjusting the pad, you have to lock it again

(4) Release the set screw with a 2mm hex wrench in this way.

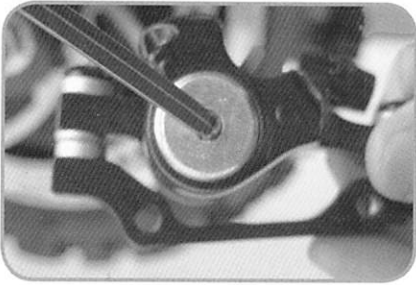

(5) Next, turn the pad clockwise with a 5mm hexagon wrench to make the pad closer to the disc, and turn it counterclockwise to move the pad away from the disc.

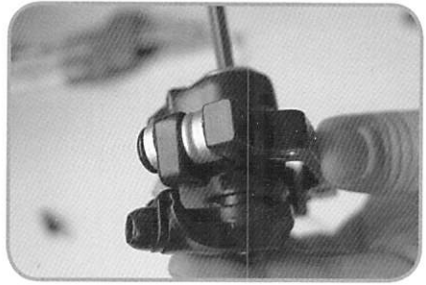

(6) Turn it clockwise in this state.

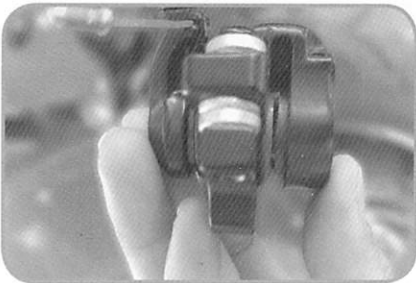

(7) It will enter as shown in the picture.



(8) When reassembling, the left and right alignment may not match. In this case, the two upper bolts are loosened as shown in the picture to adjust the calipers' body to the left and right.

4) Tire replacement method

The Dualtron Ultra is equipped with a 11inch wide tire and an easy wheel repair system for safety and maintenance convenience. The 2pcs wheel which is easy to remove and replace which makes possible the self maintenance much more convenient at the time of the puncture.

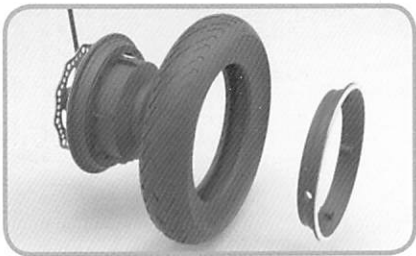

(1) Structure of the Dualtron Ultra wide tube tire

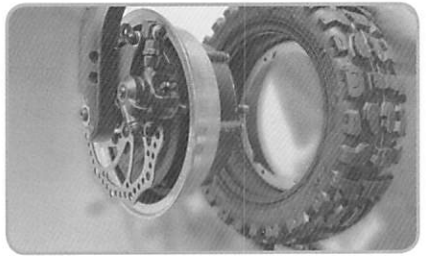

(2) Remove the tire from the body.

Maintenance

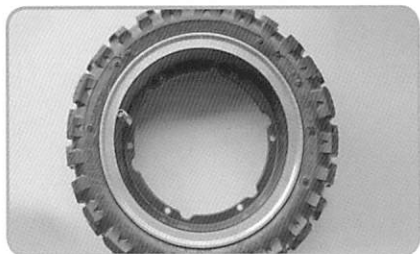

[3] Separate the wheel and the motor with a tool.

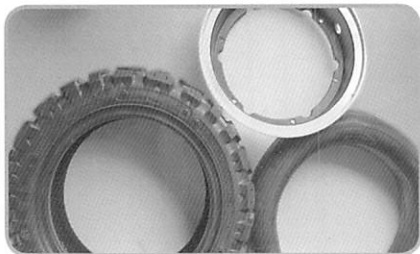

[4] Separate the tire and tube.

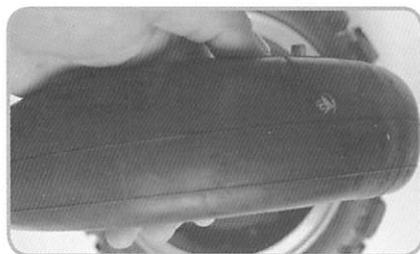

[5] Replace the tube with a new tube if the puncture part of the tube is too big to repair.



[6] After replacing, please finish assembly of tire in reverse order



[7] After the assembled tire, assemble it to fit the body properly



[8] Fasten the screws and bolts.

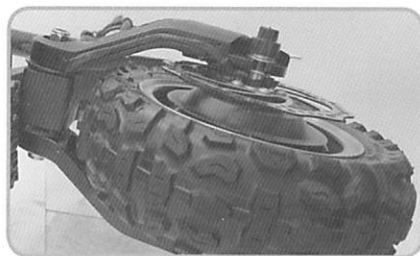

[9] Replacement of tire is completed

5) Causes and countermeasures for noise of disc brake

The disc braking system has a good braking power, so many electric scooters use disc brake system. However, if you get a sharp chirping sound when you take a disc brake, you can make a simple correction in the following way. Most of the causes of disc brake noise are dust or sand scattered on the ground during driving, which caused foreign substances to adhere to the brake pad or disc surface.

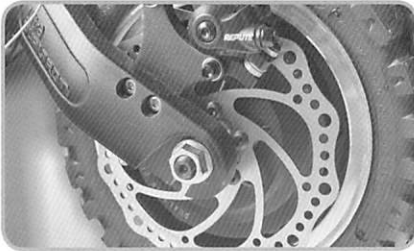

(1) It is a common disc pad and caliper.

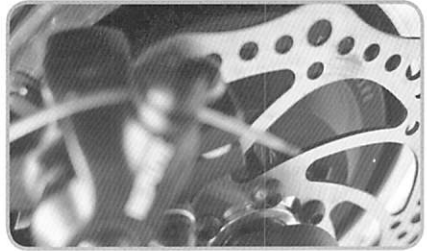

(2) There is a stripe on the part where the pad touches, but it does not look dirty when you see it with your eyes.



(3) Prepare a clean, dry cloth.



(4) Wipe the inner side of the disc while rotating the wheel.



(5) Turn it several times and wipe.

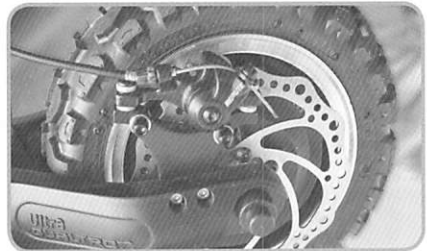

(6) Brake sound is simply eliminated..

* To prevent accidents, it should be checked before use and during use.
If any strange symptom is detected or found, immediately stop to use and self check or visit near repair shop and you can use the product safely after checking.

* Throttle

- Check that the accelerator throttle lever is operating properly before starting the machine.
- If the throttle lever is pulled or released, it may cause a malfunction by sudden operation or impact.
- Acceleration during driving. When the throttle lever returns to its original position, (It is designed to automatically shut off the motor power when braking with brake)
- It is necessary to check or replace when there is a feeling of abnormality (big gap, etc.) or a big impact on the throttle.
- We recommend that you use after checking if there is loosen bolts or lost bolts for the throttle and casing fixing bolt.
- Apply grease to the operative part of the throttle lever to maintain smooth operation

* Folding parts

If there is a collision, a fall, a heavy load on the steering wheel, or a heavy shock, the stress can be accumulated on the folding related parts such as the upper and lower hinges and the fixing bolts. It is not a permanent part which may be weakened due to fatigue damage and deformation, and it is necessary to replace parts after a certain period of use

* Folding parts QR lever and slider

- Check if the handlebar is not moving. Check the tightness of the QR lever.
- Check the tightness between the QR slider and the headset nut, and tighten the QR lever firmly enough to secure it.
- When the gap occurs, it must be used after inspection and solve the problem.

Caution

*Caution before using

- (1) In order to use the product safely, it is necessary to read and understand the instruction manual including this explanation fully.
- (2) When using the product, wear a full face helmet to protect all of the head, and wear a joint protector such as upper body protector, gloves, knee protector, and elbow protector
- (3) Keep in mind that it may cause a safety accident if clothes, bag, shoelace, fingers, hair, etc. are caught in the rotating part (motor, tire, wheel, disc) or folding part.
- (4) Shoes that interfere with safe operation such as slippers, high heels, etc. are used for reasons of accident.
- (5) Drive with drink, unlicensed, boarding more than one person, cargo loading are prohibited
- (6) Avoid acrobatics, stunts, etc. that cause safety accidents or product malfunctions.
- (7) Do not allow water to flow into the product without waterproofing [Ex. washing with water], causing condensation (moving to the place greatly different temperature in winter). Do not run on wet roads in rain or snow.
- (8) Be sure to hold the handle firmly with both hands and always prepare to hold the brake in case of unforeseen circumstances.
- (9) The built-in DC converter is prohibited to use additional connection for LED tuning or other purposes.

*Caution for the Li-Ion battery

- (1) Only charge with genuine charger
- (2) Disassembly, immersion, or alteration are prohibited
- (3) Charge at 0 ~ 45 °C, discharge at -20 ~ 60 °C
- (4) When storing for a long period, charge 70 ~ 80% of the battery
- (5) If overheating, smoke or ignition is detected in the battery compartment, immediately stop the use and charging and move the product outdoors and use a fire extinguisher to extinguish the fire.

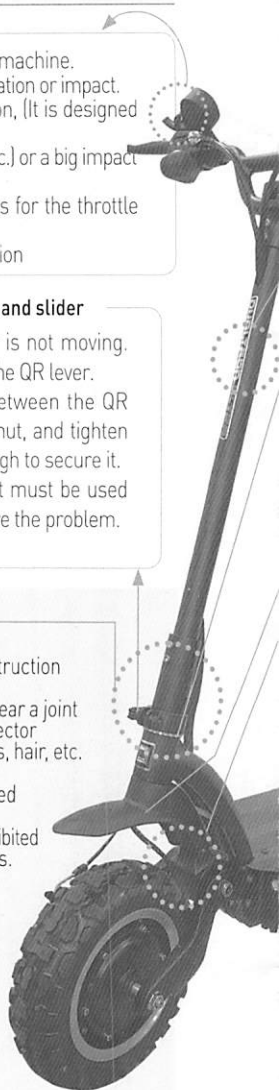

* Grip

Use it after solve the problem when there is turning or falling from the handlebar.

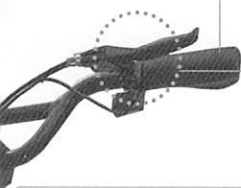

* Brake cable

- Connection of lever and brake caliper.
- If the cable does not work properly, it should be used after replacement.

* Brake lever

- Use after inspection or replacement if there is a big impact such as large gap or fall
- If the motor cut-off wiring is damaged and the motor power cut-off operation is bad, be sure to use after solve the problem
- Always check if there is enough braking power before driving.

* Handlepost column

- Check the tightening of the bolt and nut on each fixing part of the handle.
- Do not install excessive attachments (baskets, bags, etc.) on the columns and handles. Excessive load can cause difficulties in steering and folding, which can cause safety accidents.

* Headset bearing

- Keep operation smooth
- Use after remove the gap

* Side stand

Do not use excessive force on the side stand as it will cause damage to the product or cause a safety accident if you ride or ride the product while standing on the side stand.

✓ Check fastening status of low hinge fixing bolt



Fron&rear suspension

- If the exterior of the tire touches or comes close to the body when the suspension is operated or the resilience is reduced after a certain period of use,
- The performance of rubber suspension depends on the seasonal temperature difference and the user's weight due to the nature of the rubber material.

Daily check

*Major checklist

- (1) After confirming the fastening condition of the fixing bolts and nuts such as tires, wheels, motors, discs, brakes, handles, wheels,
- (2) Immediate replacement after tire damage, uneven wear or abnormal wear
- (3) The air pressure of the tire is always checked before driving and injected at a proper air pressure (50 psi).
- (4) Confirmation of brake (disc or drum brake) operation status and check of the pad consumption condition.
- (5) If calibration is impossible due to deformation of the disc, use after replacing.

*It should be used after confirming the fastening condition of bolts and nuts and the loss of parts for all parts of the product except for unspecified parts.

*Don't use the throttle to release the cruise function: When switching single mode to dual drive mode in a cruise mode, cruise mode can not be released by using throttle and can only be released via the brakes.

*Caution when use cruise function: Be sure to travel in a position where the brake can be used immediately so that the brake can be applied.

Product Name	Dualtron Ultra	DUALTRON ULTRA (Electric Scooter)	
Motor	Max 5,400W BLDC DUAL HUB MOTOR		
Battery	ULTRA	Li-Ion battery	
Battery capacity	2,072Wh	60V,35Ah	
Product weight	Around 37kg	Battery including weight Body : 28kg / Battery: 9kg	
Charging time(2A)	17hr+	When using 2A charger	Depending on the battery condition
Charging time(4A)	8hr+	When using 2units of 2A charger	
Charging time(6.5A)	5hr+	When using a rapid charger(6.5A)	
Max speed(Du)	Max 75-80km/h	75kg, 67.2V, full charging, flat road continuous running basis	
Mileage (ECO)	100-120km	*Max mileage could be shorter depending on the driving environment. 3 step speed adjustment on the Instrument panel and single&dual mode select function	
Gradeability	Around 70%(Around 35°)	Gradeability depends on the weight of the user, road condition, battery condition, temperature.	
Max load	150kg	Max 120kg is recommended	
Folding	Handle post two touch double folding	Patent pending	
Unfolded size	1235 x 600 x 1219mm	Length x Width x Height	Deck width 310mm
Folded size	1235 x 600 x 525mm	Length x Width x Height	Handle width 600mm
Instrument panel	Multifunction smart LCD instrument panel (Index finger type), Battery remains,	Electronic brake strength adjustment and on&off function	
Light function	Dual LED headlights & taillights, brake lights are applied as a default option	DC to DC converter is included(12V 3A output)	
Suspension	The dual full suspension unit is applied	Patented	
Brake	Dual brake and electric brake (Two functions work together when the brake lever works)	Front and rear tire common use Auto recovery charging system is applied when the brake lever works :	
Tire	11 inches (Ultra wide off-road tire)	Tire width 90mm (Proper air pressure 50psi)	
Material	Frame and handle : Aviation aluminum forging alloy, 6082-T6, Shafts : SCM440, Covers : Polypropylene		

* The specification can be changed by manufacturer without notice to improve the quality and safety for users.

* The distance on the specification is 75kg load, flat road 20km/h constant speed riding basis and the driving distance can be shortened by the driving environment and the driving way of user.

* The distance can be affected by loaded weight, wind direct (wind speed), road condition, slope and tire condition.

MEMO